

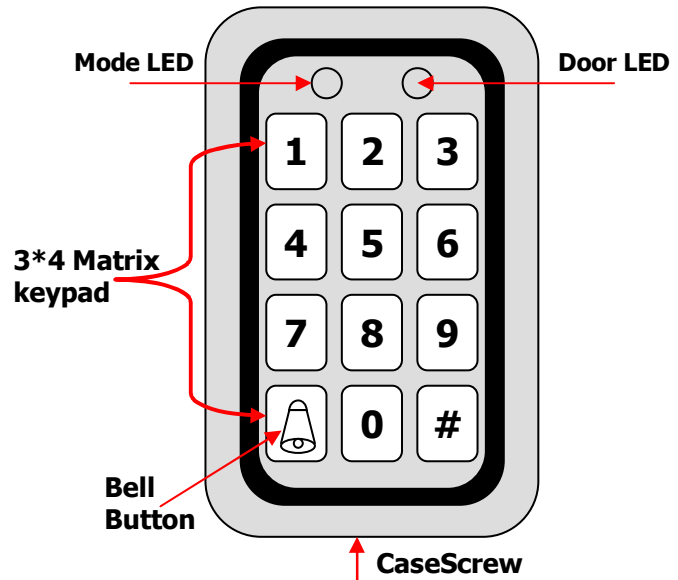

Security Trade Products

STP-DG500

Digital Keypad & Proximity Reader



KEY FEATURES:

- Built in Proximity Reader
- Built in Keypad for Code entry
- 500 user codes
- Illuminated Keys
- Auxiliary Input & Auxiliary Output
- Individually programmable Output
- 12vDC operation
- 2 Open door Modes (code only – card only)
- 1 Secure door mode (card & pin)
- Internal & external use
- Metal case construction

Technical Specification

Operating Voltage: 12vDC

Current: 130mA

Built –in Proximity reader

Compatible Cards All 26-Bit EM Cards.















Size

120 Long x 76 Wide x 27 High Dim in mm



















DG500 KEYPAD PROGRAMMING INSTRUCTIONS

(How to programme 4 digit PIN NUMBER)















	LED Sequence	
Apply 12vDC LH Green -----		
Press # (2 seconds) RH light turns Red -----		
Enter 1234 RH lights turns-----		
Enter 7 RH light turns -----		
Create a user code 3 figures (001 to 500) LH flashing (Green) RH (Red)		
Create a pin for user LH turns Green RH turns Red -----		
Press # (2 seconds) LH turns Green -----		













(How to Delete Pin)





	LED Sequence	
Keypad powered with 12vDC LH light Green -----		
Press # (2 seconds) RH light turns Red -----		
Enter 1234 LH light turns Green -----		
Enter 8 Both LH & RH lights turn Red -----		
Enter 3 digit user code (one to be removed) LH flashing Red		
Enter 1234 to confirm LH light turns Green -----		

Index	
LED out -----	
LED Green solid -----	
LED Green flashing --	
LED Red solid -----	
LED Red flashing -----	

DG500 KEYPAD PROGRAMMING INSTRUCTIONS











(How to Insert Proximity Card EM Type)	LED Sequence
Apply 12vDC LH Green -----	 
Press # (2 seconds) RH light turns Red -----	 
Enter 1234 RH lights turns Green -----	 
Enter 7 RH light turns Red -----	 
Create a user code 3 figures (001 to 500) LH flashing (Green) RH (Red)	 
Show EM Card to Keypad LH Green RH Red -----	 
Press # (2 seconds) LH light turns Green -----	 

(How to Delete Card)	LED Sequence
Keypad powered with 12vDC LH light Green -----	 
Press # (2 seconds) RH light turns Red -----	 
Enter 1234 LH light turns Green -----	 
Enter 8 Both LH & RH lights turn Red -----	 
Enter 3 digit user code (one to be removed) LH flashing Red	 
Enter 1234 to confirm LH light turns Green -----	 

Index	
LED out -----	
LED Green solid -----	
LED Green flashing --	
LED Red solid -----	
LED Red flashing -----	











DG500 KEYPAD PROGRAMMING INSTRUCTIONS

How to change Relay One





	LED Sequence	
Apply 12vDc – LH Green -----		
Press # (2 Seconds) RH turns Red-----		
Enter 1234 RH turns green -----		
Enter 6 LH flashes Green RH Green -----		
Enter 00 + 01-99 sec bleeps twice LH turns green ----		

00 denotes relay 1 next 2 digits sets time in seconds











How to change Relay Two

	LED Sequence	
Apply 12vDc – LH Green -----		
Press # (2 Seconds) RH turns Red-----		
Enter 1234 RH turns green -----		
Enter 6 LH flashes Green RH Green -----		
Enter 10 + 01-99 sec bleeps twice LH turns green ----		











10 denotes relay 2 next 2 digits sets time in seconds





Index	
LED out -----	
LED Green solid -----	
LED Green flashing --	
LED Red solid -----	
LED Red flashing -----	

DG500 KEYPAD PROGRAMMING INSTRUCTIONS
OTHER INSTRUCTIONS YOU MAY NEED

	LED Sequence
FACTORY RESET	
Apply 12vDC LH LED is Green -----	 
Enter # (2 seconds) RH LED turns RED -----	 
Enter 1234 RH LED turns Green -----	 
Enter 0 LH & RH LED turn RED both flashing-----	 
Enter 1234 LH LED turns Green -----	 

LOCK STRIKE & AUXILIART RELAY CODE ASSIGNMENT















	LED Sequence
Apply 12vDc – LH Green -----	 
Press # (2 Seconds) RH turns Red-----	 
Enter 1234 RH turns green -----	 
Enter 9 LH flashes Green RH Green -----	 
Enter 3 digit user code you need to assign too -----	 
Enter assignment digit for current User Slot (1) lock strike relay (2) Auxiliary relay (3) lock & Auxiliary	

Index	
LED out -----	
LED Green solid -----	
LED Green flashing --	
LED Red solid -----	
LED Red flashing -----	















DG500 KEYPAD PROGRAMMING INSTRUCTIONS
PROGRAMMING CARD & PIN FACILITY

PLEASE NOTE CARD AND PIN WILL ONLY WORK IN **SECURE MODE**

(How to Insert Proximity Card EM Type)









	LED Sequence	
Apply 12vDC LH Green -----		
Press # (2 seconds) RH light turns Red -----		
Enter 1234 RH lights turns Green -----		
Enter 7 RH light turns Red -----		
Create a user code 3 figures (001 to 500) LH flashing (Green) RH (Red)		
Show EM Card to Keypad LH Green RH Red -----		
Press # (2 seconds) LH light turns Green -----		





(How to programme 4 digit PIN NUMBER)

	LED Sequence	
Apply 12vDC LH Green -----		
Press # (2 seconds) RH light turns Red -----		
Enter 1234 RH lights turns-----		
Enter 7 RH light turns -----		
Create a user code 3 figures (001 to 500) LH flashing (Green) RH (Red)		
Create a pin for user LH turns Green RH turns Red -----		
Press # (2 seconds) LH turns Green -----		

TO SWITCH KEYPAD FROM NORMAL MODE TO SECURE MODE

Keypad in normal mode
#3838#
revert back to normal mode
#3838#

Index	
LED out -----	
LED Green solid -----	
LED Green flashing --	
LED Red solid -----	
LED Red flashing -----	

Programme DG500 latching mode.

To use latching mode you must use Auxiliary relay2

Stage1

for 2 seconds till red light comes on

1234

7

Create user code 3 figures (**001 to 500**)

Create pin for user 4 digit (**not 1234**)

till red light goes off

Stage 2

for 2 seconds till red light comes on

1234

9

Enter user code 3 figure number in stage 1

2

till red light goes off

Stage 3

till red light comes on

1234

6

2000

till red light goes off

When 4 figure number is put into key pad relay 2 opens

Relay is closed by putting on 4 figure number in again.

DG500

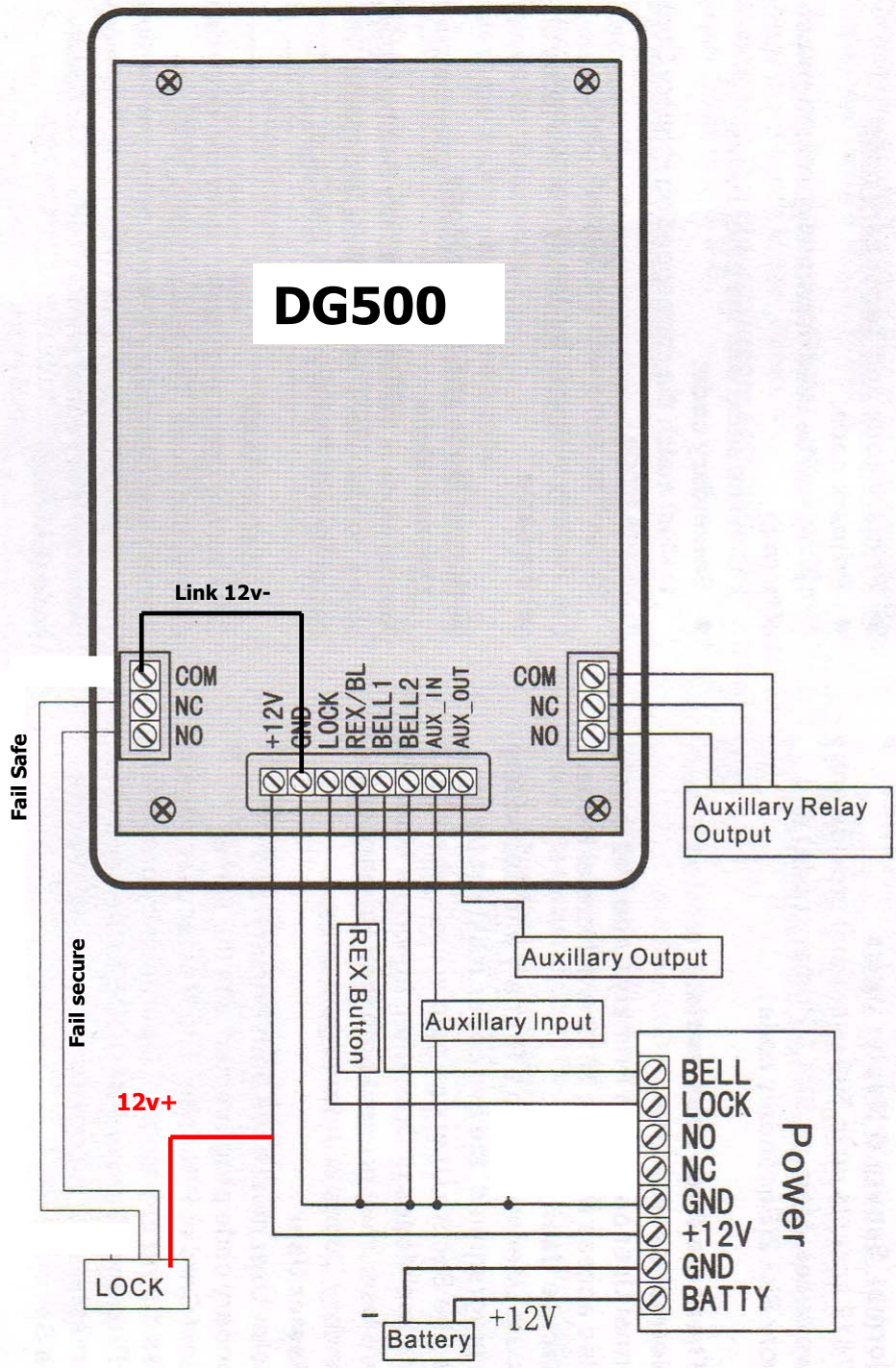

Latching Wiring

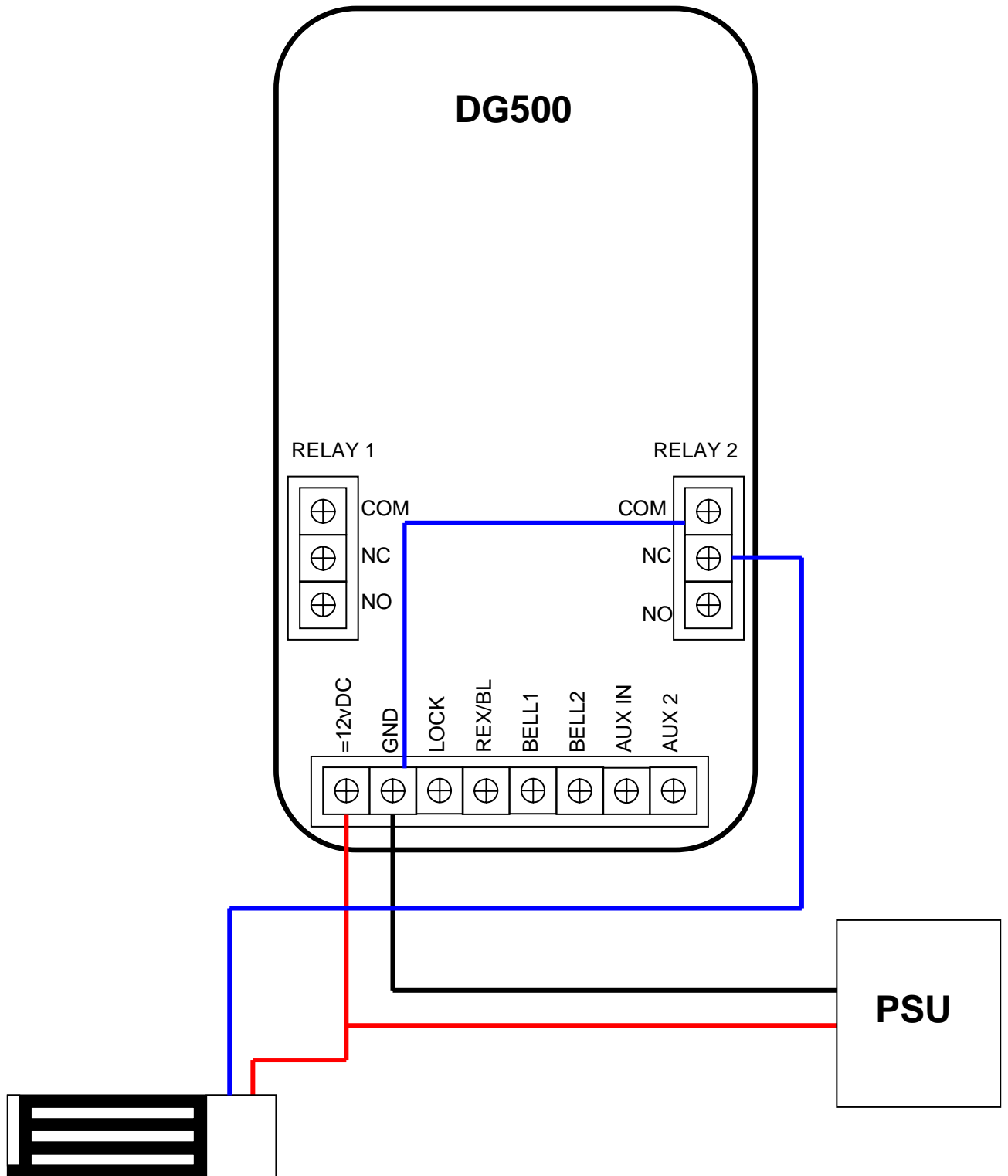

Latching mode only through relay 2.

MAGNET WIRING

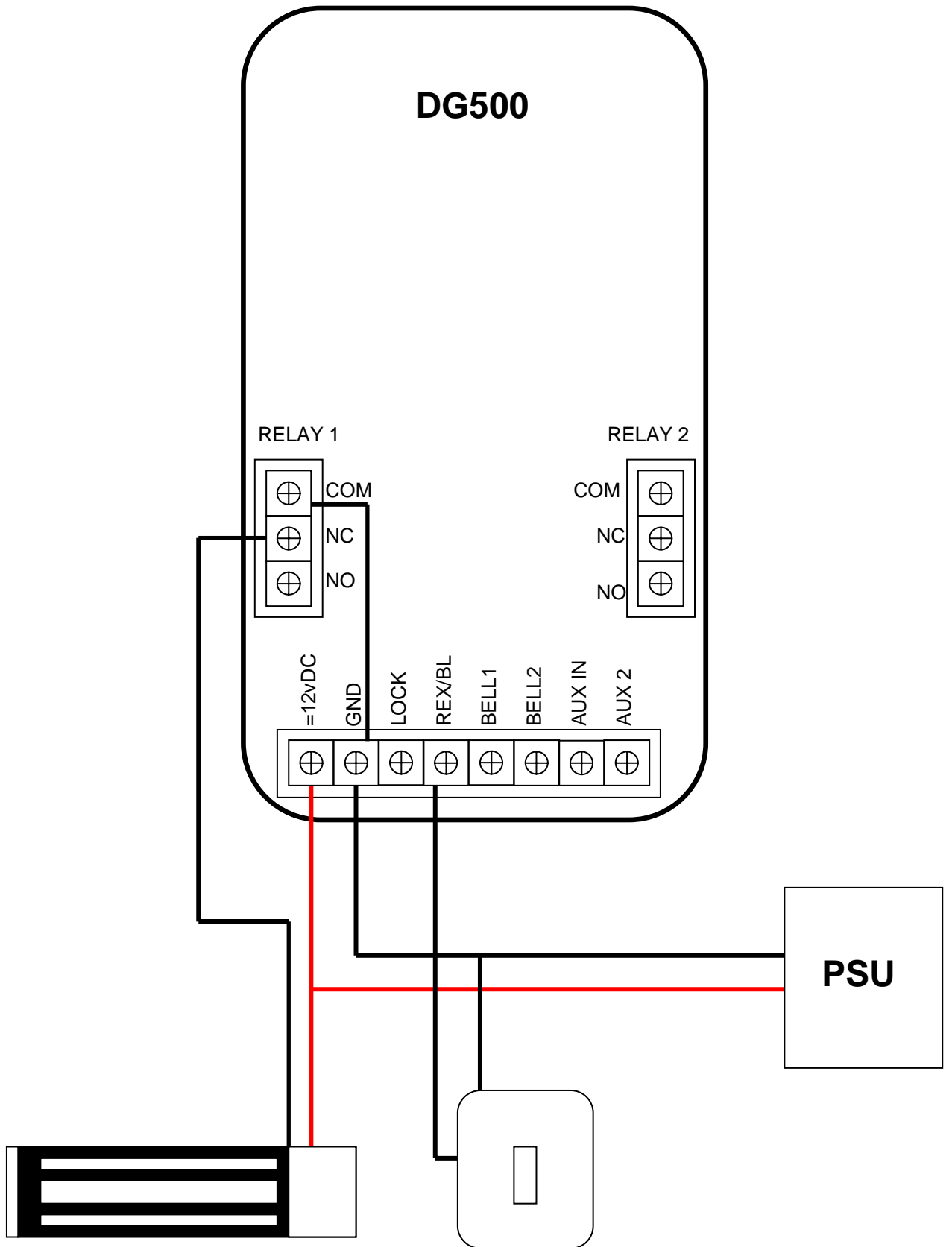

WIRING FAIL SECURE

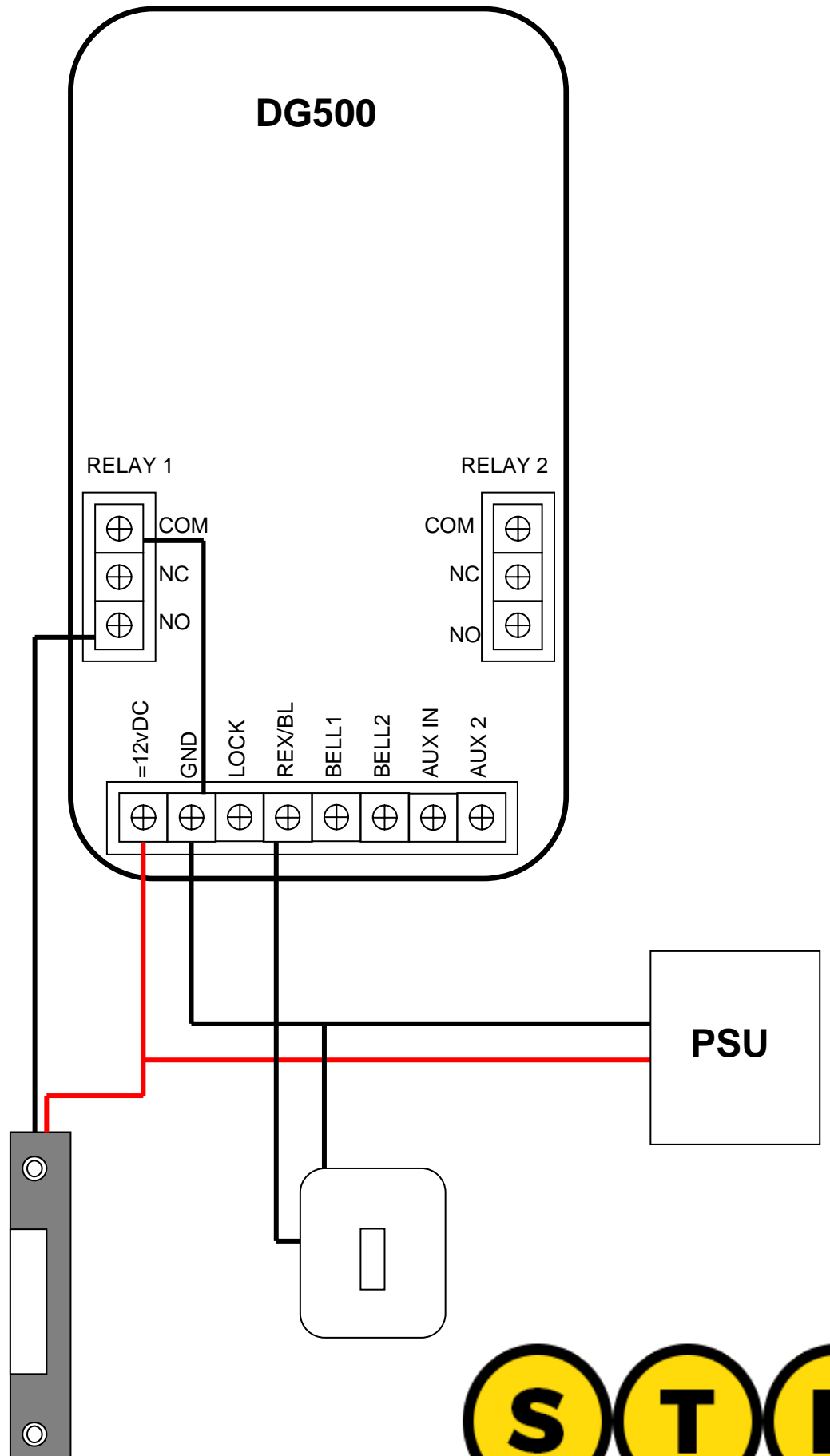

Security Trade Products